

Pioneer *sound.vision.soul*

DJ MIXER

DJM-700-S

DJM-700-K

Operating Instructions

Thank you for buying this Pioneer product.

Please read through these operating instructions so you will know how to operate your model properly. After you have finished reading the instructions, put them away in a safe place for future reference.

In some countries or regions, the shape of the power plug and power outlet may sometimes differ from that shown in the explanatory drawings. However the method of connecting and operating the unit is the same.

K015 En

IMPORTANT



The lightning flash with arrowhead symbol, within an equilateral triangle, is intended to alert the user to the presence of uninsulated "dangerous voltage" within the product's enclosure that may be of sufficient magnitude to constitute a risk of electric shock to persons.

CAUTION

RISK OF ELECTRIC SHOCK
DO NOT OPEN

CAUTION: TO PREVENT THE RISK OF ELECTRIC SHOCK, DO NOT REMOVE COVER (OR BACK). NO USER-SERVICEABLE PARTS INSIDE. REFER SERVICING TO QUALIFIED SERVICE PERSONNEL.



The exclamation point within an equilateral triangle is intended to alert the user to the presence of important operating and maintenance (servicing) instructions in the literature accompanying the appliance.

D1-4-2-3_En-A

NOTE: THE NO USER-SERVICEABLE PARTS COMPARTMENT WARNING IS LOCATED ON THE APPLIANCE BOTTOM.

IMPORTANT SAFETY INSTRUCTIONS

- 1) Read these instructions.
- 2) Keep these instructions.
- 3) Heed all warnings.
- 4) Follow all instructions.
- 5) Do not use this apparatus near water.
- 6) Clean only with dry cloth.
- 7) Do not block any ventilation openings. Install in accordance with the manufacturer's instructions.
- 8) Do not install near any heat sources such as radiators, heat registers, stoves, or other apparatus (including amplifiers) that produce heat.
- 9) Do not defeat the safety purpose of the polarized or grounding-type plug. A polarized plug has two blades with one wider than the other. A grounding type plug has two blades and a third grounding prong. The wide blade or the third prong are provided for your safety. If the provided plug does not fit into your outlet, consult an electrician for replacement of the obsolete outlet.
- 10) Protect the power cord from being walked on or pinched particularly at plugs, convenience receptacles, and the point where they exit from the apparatus.
- 11) Only use attachments/accessories specified by the manufacturer.
- 12) Use only with the cart, stand, tripod, bracket, or table specified by the manufacturer, or sold with the apparatus. When a cart is used, use caution when moving the cart/apparatus combination to avoid injury from tip-over.
- 13) Unplug this apparatus during lightning storms or when unused for long periods of time.
- 14) Refer all servicing to qualified service personnel. Servicing is required when the apparatus has been damaged in any way, such as power-supply cord or plug is damaged, liquid has been spilled or objects have fallen into the apparatus, the apparatus has been exposed to rain or moisture, does not operate normally, or has been dropped.



P1-4-2-2_En

NOTE: This equipment has been tested and found to comply with the limits for a Class B digital device, pursuant to Part 15 of the FCC Rules. These limits are designed to provide reasonable protection against harmful interference in a residential installation. This equipment generates, uses, and can radiate radio frequency energy and, if not installed and used in accordance with the instructions, may cause harmful interference to radio communications. However, there is no guarantee that interference will not occur in a particular installation. If this equipment does cause harmful interference to radio or television reception, which can be determined by turning the equipment off and on, the user is encouraged to try to correct the interference by one or more of the following measures:

- Reorient or relocate the receiving antenna.
- Increase the separation between the equipment and receiver.
- Connect the equipment into an outlet on a circuit different from that to which the receiver is connected.
- Consult the dealer or an experienced radio/TV technician for help.

D8-10-1-2_En

When using this product follow the instructions written on the underside of the unit, which concern rated voltage, etc.

D3-4-2-2-4_En

CAUTION

The POWER switch on this unit will not completely shut off all power from the AC outlet. Since the power cord serves as the main disconnect device for the unit, you will need to unplug it from the AC outlet to shut down all power. Therefore, make sure the unit has been installed so that the power cord can be easily unplugged from the AC outlet in case of an accident. To avoid fire hazard, the power cord should also be unplugged from the AC outlet when left unused for a long period of time (for example, when on vacation).

D3-4-2-2a_A_En

WARNING

This equipment is not waterproof. To prevent a fire or shock hazard, do not place any container filled with liquid near this equipment (such as a vase or flower pot) or expose it to dripping, splashing, rain or moisture.

D3-4-2-1-3_A_En

IMPORTANT NOTICE – THE SERIAL NUMBER FOR THIS EQUIPMENT IS LOCATED ON THE BOTTOM. PLEASE WRITE THIS SERIAL NUMBER ON YOUR ENCLOSED WARRANTY CARD AND KEEP IN A SECURE AREA. THIS IS FOR YOUR SECURITY.

D1-4-2-6-1_En

Information to User

Alteration or modifications carried out without appropriate authorization may invalidate the user's right to operate the equipment.

D8-10-2_En

CAUTION: This product satisfies FCC regulations when shielded cables and connectors are used to connect the unit to other equipment. To prevent electromagnetic interference with electric appliances such as radios and televisions, use shielded cables and connectors for connections.

D8-10-3a_En

This Class B digital apparatus complies with Canadian ICES-003.

Cet appareil numérique de la Classe B est conforme à la norme NMB-003 du Canada.

D8-10-1-3_En

CAUTION – PREVENT ELECTRIC SHOCK DO NOT USE THIS (POLARIZED) PLUG WITH AN EXTENSION CORD, RECEPTACLE OR OTHER OUTLET UNLESS THE BLADES CAN BE FULLY INSERTED TO PREVENT BLADE EXPOSURE.
ATTENTION – POUR PREVENIR LES CHOCES ELECTRIQUES NE PAS UTILISER CETTE FICHE POLARISEE AVEC UN PROLONGATEUR UNE PRISE DE COURANT OU UNE AUTRE SORTIE DE COURANT, SAUF SI LES LAMES PEUVENT ETRE INSEREES A FOND SANS EN LAISSER AUCUNE PARTIE A DECOUVERT.

D2-4-4-1_En

WARNING: Handling the cord on this product or cords associated with accessories sold with the product will expose you to chemicals listed on proposition 65 known to the State of California and other governmental entities to cause cancer and birth defect or other reproductive harm.

Wash hands after handling

D36-P4_A_En

WARNING

To prevent a fire hazard, do not place any naked flame sources (such as a lighted candle) on the equipment.

D3-4-2-1-7a_A_En

VENTILATION CAUTION

When installing this unit, make sure to leave space around the unit for ventilation to improve heat radiation (at least 5 cm at rear, and 3 cm at each side).

WARNING

Slots and openings in the cabinet are provided for ventilation to ensure reliable operation of the product, and to protect it from overheating. To prevent fire hazard, the openings should never be blocked or covered with items (such as newspapers, table-cloths, curtains) or by operating the equipment on thick carpet or a bed.

D3-4-2-1-7b_A_En

POWER-CORD CAUTION

Handle the power cord by the plug. Do not pull out the plug by tugging the cord and never touch the power cord when your hands are wet as this could cause a short circuit or electric shock. Do not place the unit, a piece of furniture, etc., on the power cord, or pinch the cord. Never make a knot in the cord or tie it with other cords. The power cords should be routed such that they are not likely to be stepped on. A damaged power cord can cause a fire or give you an electrical shock. Check the power cord once in a while. When you find it damaged, ask your nearest PIONEER authorized service center or your dealer for a replacement.

S002_En



Dear Customer:

Selecting fine audio equipment such as the unit you've just purchased is only the start of your musical enjoyment. Now it's time to consider how you can maximize the fun and excitement your equipment offers. This manufacturer and the Electronic Industries Association's Consumer Electronics Group want you to get the most out of your equipment by playing it at a safe level. One that lets the sound come through loud and clear without annoying blaring or distortion-and, most importantly, without affecting your sensitive hearing.

Sound can be deceiving. Over time your hearing "comfort level" adapts to higher volumes of sound. So what sounds "normal" can actually be loud and harmful to your hearing. Guard against this by setting your equipment at a safe level BEFORE your hearing adapts.

To establish a safe level:

- Start your volume control at a low setting.
- Slowly increase the sound until you can hear it comfortably and clearly, and without distortion.

Once you have established a comfortable sound level:

- Set the dial and leave it there.

Taking a minute to do this now will help to prevent hearing damage or loss in the future. After all, we want you listening for a lifetime.

We Want You Listening For A Lifetime

Used wisely, your new sound equipment will provide a lifetime of fun and enjoyment. Since hearing damage from loud noise is often undetectable until it is too late, this manufacturer and the Electronic Industries Association's Consumer Electronics Group recommend you avoid prolonged exposure to excessive noise. This list of sound levels is included for your protection.

Decibel Level Example

30	Quiet library, soft whispers
40	Living room, refrigerator, bedroom away from traffic
50	Light traffic, normal conversation, quiet office
60	Air conditioner at 20 feet, sewing machine
70	Vacuum cleaner, hair dryer, noisy restaurant
80	Average city traffic, garbage disposals, alarm clock at two feet.

THE FOLLOWING NOISES CAN BE DANGEROUS UNDER CONSTANT EXPOSURE

90	Subway, motorcycle, truck traffic, lawn mower
100	Garbage truck, chain saw, pneumatic drill
120	Rock band concert in front of speakers, thunderclap
140	Gunshot blast, jet plane
180	Rocket launching pad

Information courtesy of the Deafness Research Foundation.



5001_En

Operating Environment

Operating environment temperature and humidity: +5 °C – +35 °C (+41 °F – +95 °F); less than 85 %RH (cooling vents not blocked)

Do not install this unit in a poorly ventilated area, or in locations exposed to high humidity or direct sunlight (or strong artificial light)

D3-4-2-1-7c_A_En

WARNING

Before plugging in for the first time, read the following section carefully.

The voltage of the available power supply differs according to country or region. Be sure that the power supply voltage of the area where this unit will be used meets the required voltage (e.g., 230V or 120V) written on the bottom panel.

D3-4-2-1-4_A_En mod

If the AC plug of this unit does not match the AC outlet you want to use, the plug must be removed and appropriate one fitted. Replacement and mounting of an AC plug on the power supply cord of this unit should be performed only by qualified service personnel. If connected to an AC outlet, the cut-off plug can cause severe electrical shock. Make sure it is properly disposed of after removal. The equipment should be disconnected by removing the mains plug from the wall socket when left unused for a long period of time (for example, when on vacation).

D3-4-2-1a_A_En

Contents

CONFIRM ACCESSORIES.....	4	EFFECT FUNCTIONS	16
CAUTIONS REGARDING HANDLING.....	4	PRODUCING BEAT EFFECTS.....	18
Location	4	MANUAL FILTER OPERATION.....	19
Cleaning the Unit.....	4	EFFECT FREQUENCY FILTER OPERATION.....	19
FEATURES	4	EFFECT PARAMETERS.....	20
CONNECTIONS	5	MIDI SETTINGS	21
CONNECTION PANEL	5	SYNCHRONIZING AUDIO SIGNALS TO EXTERNAL SEQUENCER, OR USING DJM-700-S/DJM-700-K INFORMATION TO OPERATE AN EXTERNAL SEQUENCER	21
CONNECTING INPUTS	6	MIDI MESSAGES	22
CONNECTING EXTERNAL EFFECTORS, OUTPUT CONNECTORS	7	PROGRAM CHANGE	24
ABOUT MIDI CONNECTORS.....	8	SNAPSHOT.....	24
CONNECTING MICROPHONE AND HEADPHONES	8	MIDI ON/OFF	24
CONNECTING THE POWER CORD	8	TROUBLESHOOTING	25
NAMES AND FUNCTIONS OF PARTS	9	SPECIFICATIONS	26
MIXER OPERATIONS.....	13	BLOCK DIAGRAM	27
FADER START FUNCTION	14		

CONFIRM ACCESSORIES

Operating Instructions.....1

CAUTIONS REGARDING HANDLING

Location

Install the unit in a well-ventilated location where it will not be exposed to high temperatures or humidity.

- Do not install the unit in a location which is exposed to direct rays of the sun, or near stoves or radiators. Excessive heat can adversely affect the cabinet and internal components. Installation of the unit in a damp or dusty environment may also result in a malfunction or accident. (Avoid installation near cookers etc., where the unit may be exposed to oily smoke, steam or heat.)
- When the unit is used inside a carrying case or DJ booth, separate it from the walls or other equipment to improve heat radiation.

Cleaning the Unit

- Use a polishing cloth to wipe off dust and dirt.
- When the surfaces are very dirty, wipe with a soft cloth dipped in some neutral cleanser diluted five or six times with water and wrung out well, then wipe again with a dry cloth. Do not use furniture wax or cleaners.
- Never use thinners, benzene, insecticide sprays or other chemicals on or near this unit, since these will corrode the surfaces.

FEATURES

Designed for high sound quality

Analog signals are transmitted by the shortest circuitry and converted to digital format at 96 kHz sampling rate via a 24-bit high quality A/D converter. As a result, signals are passed to the digital mixing stage in the best possible state. Mixing is performed with a 32-bit DSP, totally eliminating any loss in fidelity, while the ideal level of filtering is introduced to produce optimum sound for DJ play.

These features are housed in a high-rigidity chassis with high-output power section and other features that carry on the high-fidelity performance of the DJM-1000, thus ensuring the utmost in clear and powerful club sound.

Manual Filter

This unit features Manual Effector for more intuitive setting of effects, thus expanding the potential range of DJ play. In addition, by combining this with "beat effects," an even wider range of effects can be produced, allowing a tremendous variety of remix and DJ play.

Beat effects

The "beat effects" so popular on the DJM-600 are continued here. Effects can be applied in linkage to the BPM (Beats Per Minute) count, thus allowing the production of a variety of sounds. Equipped with a broad range of special effects, including delay, echo, trans, filter, flanger, phaser, reverb, robot, crush, roll, reverse roll, uproll, and downroll.

This unit features an "effect frequency filter" allowing the user to limit what frequency bands are subjected to effects, and which are not. This enhances the degree of audio expression compared to conventional effecters that are applied to the entire frequency range.

Digital OUT

The digital output connectors support sampling rates 96 kHz/24-bit format and 48 kHz/24-bit format, making the unit even more convenient for cutting studio tracks or on other occasions when high sound fidelity is required. (Only linear PCM is supported.)

MIDI OUT

Virtually all the dial and switch information of the DJM-700-S/DJM-700-K can be output in MIDI signal format, allowing a component supporting MIDI control to be controlled via MIDI.

Other functions

- A control cable can be used to connect the unit to a Pioneer DJ CD player, thus allowing playback to be linked to operation of the fader ("fader start play").
- Built-in "3-band equalizer" supports level control within the range of +6 dB to -26 dB in each bandwidth.
- "Cross fader assignment" function allows each channel's input to be assigned flexibly to a cross fader.
- "Talk over" function automatically lowers track volume during microphone input.
- "Fader curve adjustment" function allows modification of the cross fader and channel fader curves.

CONNECTIONS

CONNECTION PANEL

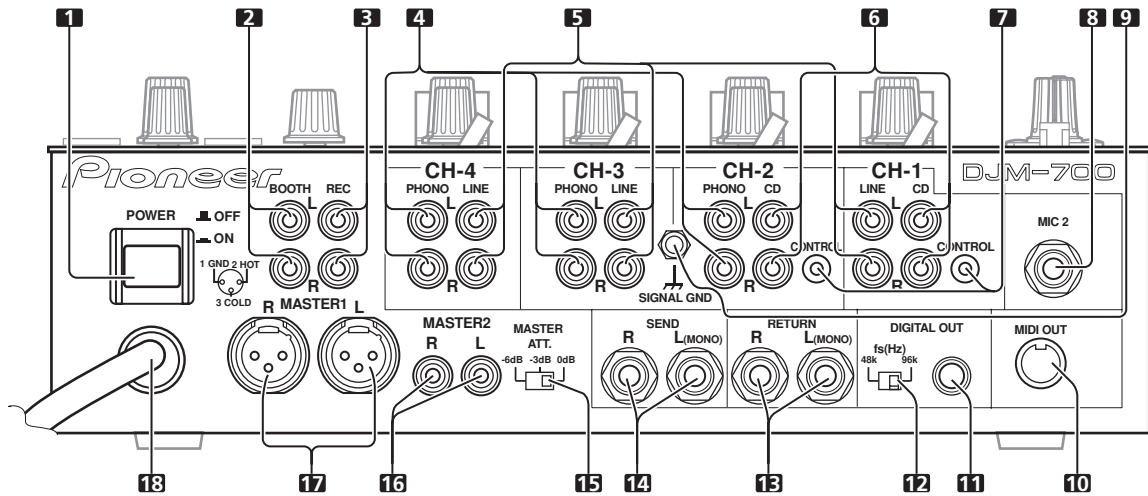

1 POWER switch

2 BOOTH monitor output connectors

RCA-type booth monitor output jack. The sound level from these connectors is controlled independently by the **BOOTH MONITOR LEVEL** dial, regardless of the position of the **MASTER LEVEL** dial.

3 Recording output connectors (REC)

RCA type output connectors for recording.

4 PHONO input connectors

RCA type phono level (MM cartridge) input connectors. Do not use for inputting line level signals.

5 LINE input connectors

RCA type line level input connectors. Use to connect a cassette deck or other line level output component.

6 CD input connectors

RCA type line level input connectors. Use to connect a DJ CD player or other line level output component.

7 CONTROL connectors

Ø3.5 mm mini-connector. Use to connect to the control connector of a Pioneer DJ CD player. When the connectors are connected, the DJM-700-S/DJM-700-K's fader can be used to perform start/stop on the DJ CD player.

8 Two microphone input jacks (MIC 2)

Connect microphones equipped with phone-type plugs.

9 Signal grounding terminals (SIGNAL GND)

Reduces noise when connecting an analog turntable.

10 MIDI OUT connector

DIN type output connector. Use to connect to other MIDI component (see P. 21).

11 DIGITAL OUT connector

RCA type digital coaxial output connector. Master audio digital output.

12 Sampling frequency selector switch (fs 48 k/96 k)

Use to set the sampling frequency of the digital output to 96 kHz/24-bit format or 48 kHz/24-bit format.

- Turn power off before changing this switch position.

13 RETURN connectors

Ø6.3 mm phone-type input connectors. Use to connect to the output connectors of external effectors or similar components. When the L channel only is connected, the L channel input is simultaneously input to the R channel.

14 SEND output connectors

Ø6.3 mm phone-type output connectors. Use to connect to the input connectors of external effectors or other similar components. When the L channel only is connected, a L+R monaural signal is output.

15 Master output attenuator switch (MASTER ATT)

Use to attenuate the level of the master 1 and master 2 outputs. Attenuation can be set to 0 dB, -3 dB, or -6 dB.

16 MASTER 2 output connectors

RCA type unbalanced output.

17 MASTER 1 output connectors

XLR type (male) balanced output.

- When using a cord with RCA-type plug, users are recommended to connect the plug directly to the **MASTER 2** connectors without using an XLR/RCA converter plug.

18 Power cord

Connect to ordinary AC outlet.

CONNECTIONS

Always turn off the power switch and disconnect the power plug from its outlet when making or changing connections.

CONNECTING INPUTS

Pioneer DJ CD players

The audio output connectors of a DJ-type CD player can be connected to the **CD** input connectors (channel 1 or 2), or to the **LINE** input connectors (channel 1) of the DJM-700-S/DJM-700-K. Connect the control cord to the **CONTROL** jack, and set the input selector switch to [**CD**] or [**LINE**].

Analog turntable

To connect an analog turntable, connect the turntable's audio output cable to one of the channel 2 to 4 **PHONO** input connectors. Set the corresponding channel's input selector switch to [**PHONO**]. The DJM-700-S/DJM-700-K's **PHONO** inputs support MM cartridges.

Connect the ground wire from an analog turntable to the **SIGNAL GND** terminal of the DJM-700-S/DJM-700-K.

- Note that no **PHONO** input connector is provided for channel 1.

Connecting other line level output devices

To use a cassette deck or ordinary CD player, connect its audio output connectors to one of the DJM-700-S/DJM-700-K's **LINE** input connectors (channel 1, 3, or 4) or to the **CD** input connectors (channel 1 or 2), and set the input selector switch to [**LINE**].

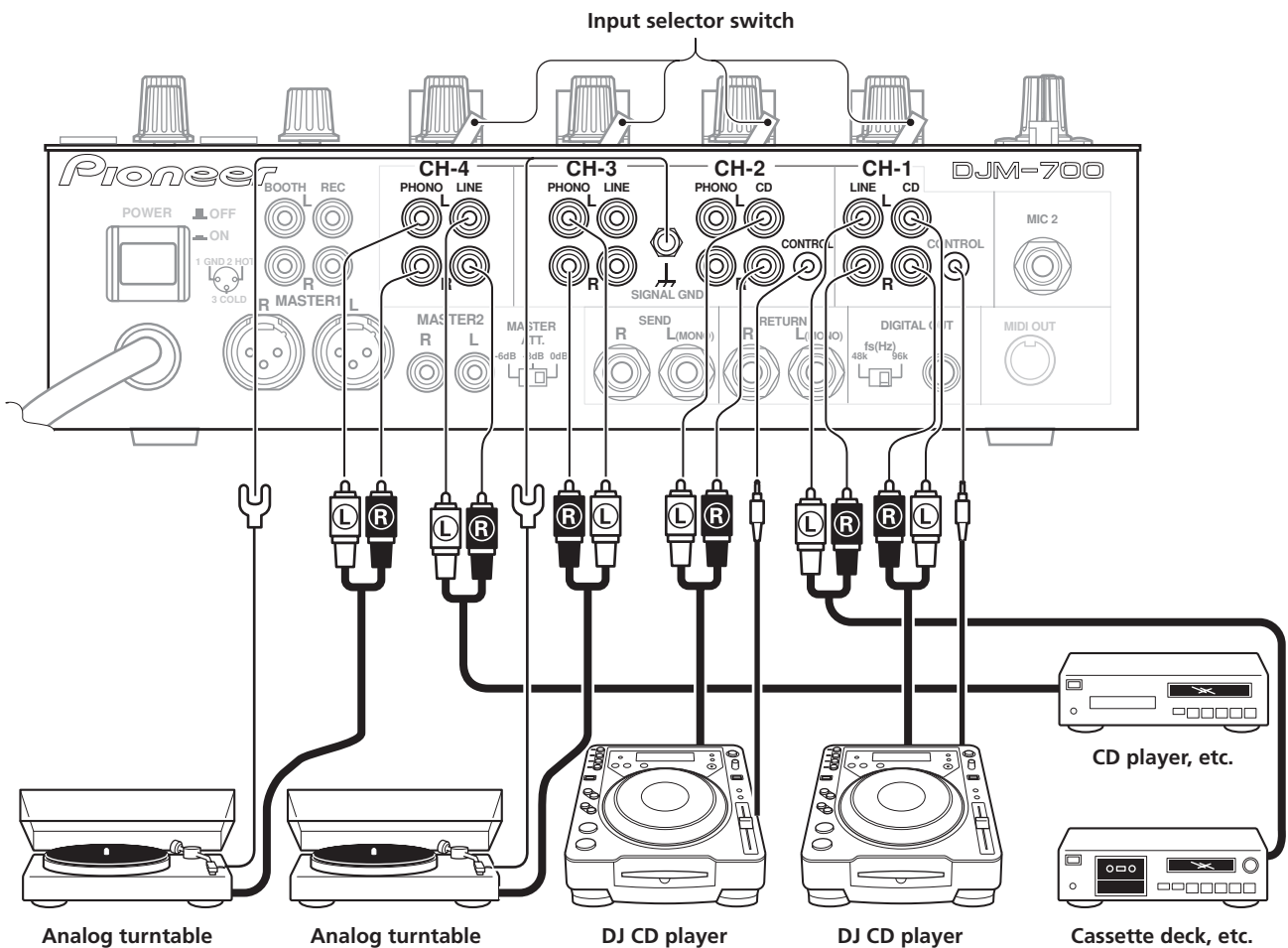

CONNECTIONS

CONNECTING EXTERNAL EFFECTORS, OUTPUT CONNECTORS

Master output

This unit is furnished with balanced output **MASTER 1** (supporting XLR plugs), and unbalanced output **MASTER 2** (supporting RCA plugs).

Using the **MASTER ATT** switch, adjust the output level to match the input sensitivity of the power amplifier used.

If the operating panel's **MONO/STEREO** switch is set to **[MONO]**, the master output will be a monaural combination of L+R channels.

Booth monitor output

Unbalanced output supporting RCA-type plug. The sound volume for this output is controlled by the **BOOTH MONITOR LEVEL** dial, independently of the master output level setting.

Recording output

These are output connectors for recording, supporting RCA plugs.

Digital output

This is a coaxial digital output connector, supporting RCA plugs. The sampling frequency can be set to 96 kHz/24-bit format or 48 kHz/24-bit format to match the connected device.

- Turn power off before changing this switch position.

External effector

Use a cable with Ø6.3 mm phone plugs to connect the DJ mixer's **SEND** connectors to the effector's input connectors.

When using an effector with monaural inputs, connect only to the DJ mixer's L channel output. In this way, the mixed L+R audio signal will be sent to the effector. In the same way, use a cable with Ø6.3 mm phone plugs to connect the DJ mixer's **RETURN** connectors to the output connectors of the effector.

If the effector has only monaural output, connect to the DJ mixer's L channel input only. The signal from the effector will be input to both L and R channels.

When using an external effector, set the effect selector to **[SND/RTN]**.

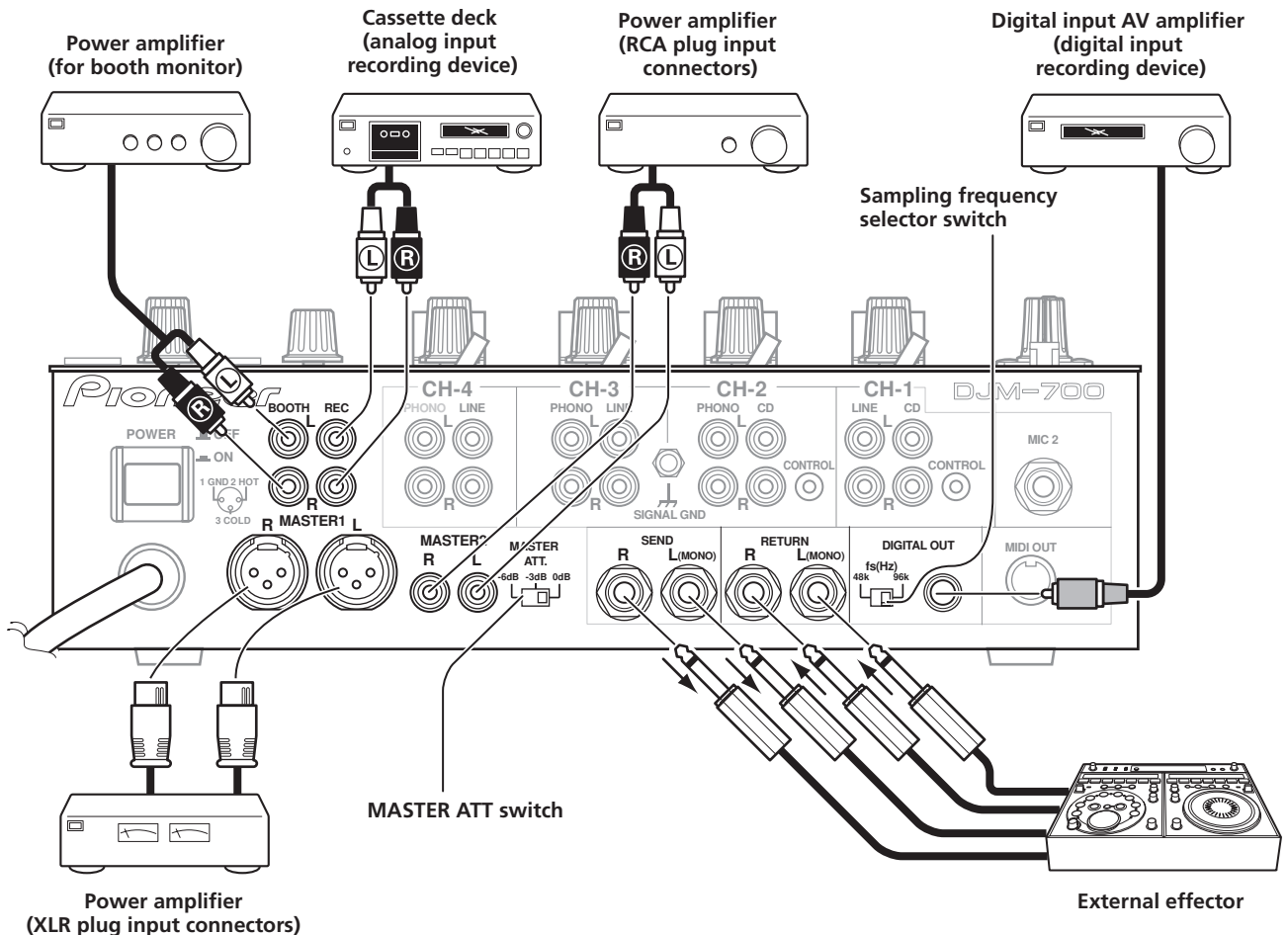

ABOUT MIDI CONNECTORS

See P. 21 regarding the functions of MIDI connectors.

CONNECTING MICROPHONE AND HEADPHONES

Microphone

A microphone with XLR-type plug can be connected to the **MIC 1** connector on the Operation Panel (upper). The **MIC 2** jack on the connection panel can be used to connect a microphone with $\varnothing 6.3$ mm phone plugs.

- When using a microphone, set the operating panel's **MIC** switch to **[ON]** or **[TALK OVER]**, and adjust the **LEVEL** dial as necessary. When not using a microphone, it is recommended to set the **MIC** switch to **[OFF]** and rotate the **LEVEL** dial fully counterclockwise to the $[-\infty]$ side.

Headphones

The **PHONES** jack on the upper surface of the operating panel can be used to connect headphones with a $\varnothing 6.3$ mm stereo phone plug.

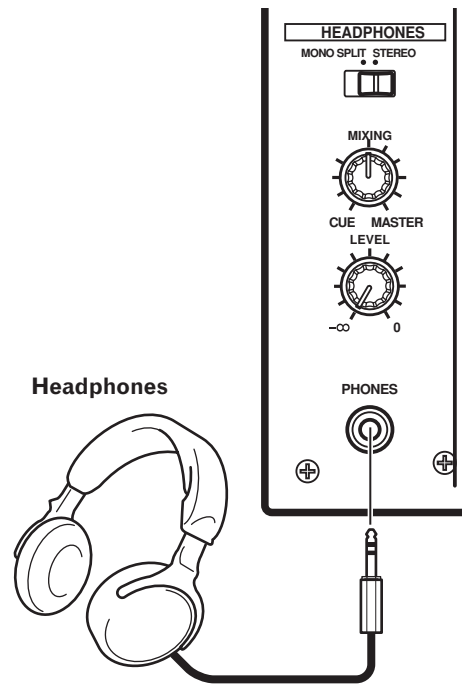
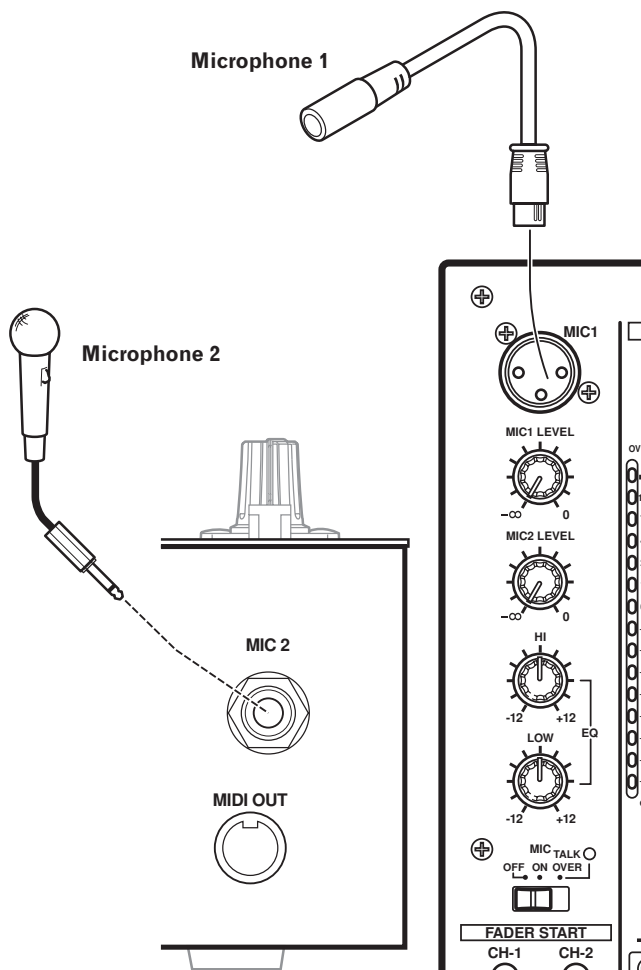

CONNECTING THE POWER CORD

Connect the power cord last.

- After completing all other connections, connect the power plug to an ordinary AC outlet.

NAMES AND FUNCTIONS OF PARTS

OPERATION PANEL

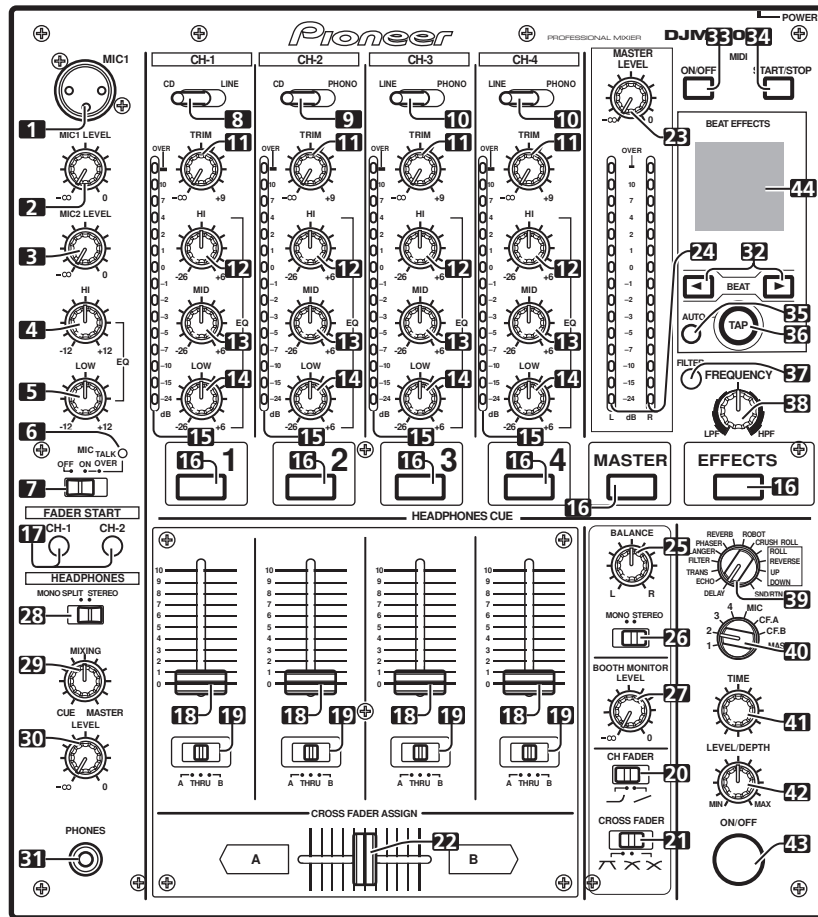

- 1 Microphone 1 input jack (MIC 1)**
Connect microphone with XLR-type plug.
- 2 Microphone 1 level control dial (MIC 1 LEVEL)**
Use to adjust the volume of microphone 1. (adjustable range $-\infty$ to 0 dB)
- 3 Microphone 2 level control dial (MIC 2 LEVEL)**
Use to adjust the volume of microphone 2. (adjustable range $-\infty$ to 0 dB)
- 4 Microphone equalizer high-range control dial (HI)**
Use to adjust the treble (high-range) frequencies of microphones 1 and 2. (adjustable range -12 dB to $+12$ dB)
- 5 Microphone equalizer low-range control dial (LOW)**
Use to adjust the bass (low-range) frequencies of microphones 1 and 2. (adjustable range -12 dB to $+12$ dB)
- 6 Microphone function indicator**
Lights when microphone is ON; flashes when **TALK OVER** is ON.
- 7 Microphone function selector switch (MIC)**
OFF:
No microphone sound is output.
ON:
Microphone sound is output normally.

- TALK OVER:**
Microphone sound is output; when sound is input to a connected microphone, the TALK OVER function operates and all sound other than that from the microphone is attenuated by 20 dB.
- When not using the TALK OVER function, it is recommended to set the switch to the **[OFF]** or **[ON]** position.
- 8 Channel 1 input selector switch**
CD:
Selects **CD** input (line level analog input).
LINE:
Use to select **LINE** input connectors.
 - 9 Channel 2 input selector switch**
CD:
Use to select **CD** input (line level analog input).
PHONO:
Use to select **PHONO** input connectors (analog turntable input).
 - 10 Channel 3, 4 input selector switch**
LINE:
Use to select **LINE** input (line level analog input).
PHONO:
Use to select **PHONO** input connectors (analog turntable input).
 - 11 TRIM adjust dial**
Use to adjust the input level for each channel. (adjustable range: $-\infty$ to $+9$ dB, mid-position is about 0 dB)
 - 12 Channel equalizer high-range adjust dial (HI)**
Use to adjust the treble (high-range) frequency sound for each channel. (adjustable range: -26 dB to $+6$ dB)

NAMES AND FUNCTIONS OF PARTS

13 Channel equalizer mid-range adjust dial (MID)

Use to adjust the mid-range frequency sound for each channel. (adjustable range: -26 dB to +6 dB)

14 Channel equalizer low-range adjust dial (LOW)

Use to adjust the bass (low-range) frequency sound for each channel. (adjustable range: -26 dB to +6 dB)

15 Channel level indicator

Displays the current level for each channel, with two-second peak hold.

16 HEADPHONES CUE buttons/indicators

These buttons are used to select from **1** to **4**, **MASTER**, or **EFFECTS**, to allow you to monitor the desired source through headphones. If multiple buttons are pressed simultaneously, the selected audio sources are mixed. Press the button once more to cancel the selected source. Unselected buttons glow darkly, while selected source buttons light brightly.

17 Fader start button/indicator (FADER START CH-1, CH-2)

Enables the fader start/back cue function for the channel to which a DJ CD player is connected. The button lights when set to ON. When enabled, the operation differs depending on the setting of the **CROSS FADER ASSIGN** switch.

- When the **CROSS FADER ASSIGN** switch is set to the **[A]** or **[B]** position, fader start button operation is linked to the operation of the cross fader (and unlinked to channel fader).
- When the **CROSS FADER ASSIGN** switch is set to the **[THRU]** position, fader start button operation is linked to the operation of the channel fader (and unlinked to cross fader).

18 Channel fader lever

Use to adjust sound volumes for each channel. (adjustable range: -∞ to 0 dB)

Output is in accordance with the channel fader curve selected with the **CH FADER** curve switch.

19 CROSS FADER ASSIGN switch

This switch assigns each channel's output to either right or left side of the cross fader (if multiple channels are assigned to the same side, the result will be the combined sum of the channels).

A:

The selected channel is assigned to the cross fader's A (left) side.

THRU:

The channel fader's output is sent as is to the master output, without being passed through the cross fader.

B:

The selected channel is assigned to the cross fader's B (right) side.

20 Channel fader curve switch (CH FADER)

This switch allows the user to select from two types of channel fader curve response. This setting is applied equally to channels 1 to 4.

- At the left setting, the curve operates to produce a rapid rise as the channel fader approaches its distant position.
- At the right setting, the curve operates to produce an even, neutral rise throughout the channel fader's movement.

21 Cross fader curve switch (CROSS FADER)

This switch allows the user to select from three types of cross fader curve response.

- At the left setting, the curve produces a rapid signal rise. (As soon as the cross fader lever leaves the **[A]** side, the **[B]** channel sound is produced.)
- At the right setting, the curve operates to produce an even, neutral rise throughout the cross fader's movement.
- At the middle setting, an intermediate curve is produced, midway between the two curves noted above.

22 Cross fader lever

Outputs sound assigned to **[A]** and **[B]** sides in accordance with setting of the **CROSS FADER ASSIGN** switch, and subject to the cross fader curve selected with the **CROSS FADER** curve switch.

23 Master output level dial (MASTER LEVEL)

Use to adjust the master output level. (adjustable range: -∞ to 0 dB)

The master output is the sum combination of the sound from channels set to **[THRU]** with the **CROSS FADER ASSIGN** switch; the signal passed through the cross fader; and the signals from microphone 1 and microphone 2 (if the effect selector is set to **[SND/RTN]**, the **RETURN** input is also added).

24 Master level indicator (MASTER L, R)

These segment indicators display the output level from L and R channels. The indicators have a two-second peak hold.

25 Master balance dial (BALANCE)

Use to adjust the L/R channel balance for master output, booth monitor output, recording output, and digital output.

26 Master output MONO/STEREO selector switch

When set to the **[MONO]** position, master output, booth monitor output, recording output, digital output are all produced in L+R monaural.

27 BOOTH MONITOR LEVEL control dial

This dial is used to adjust the booth monitor output volume.

The volume can be adjusted independently of the master output level. (adjustable range: -∞ to 0 dB)

28 Headphones output switch (MONO SPLIT/STEREO) MONO SPLIT:

When **HEADPHONES CUE (1, 2, 3, 4 or EFFECTS)** button is selected, the selected audio is output to the L channel. When **HEADPHONES CUE (MASTER)** button is selected, the master audio is output from the R channel.

STEREO:

The audio source selected with the **HEADPHONES CUE** button is output in stereo.

29 Headphones mixing dial (MIXING)

When rotated clockwise (toward **[MASTER]**), the master output audio is produced at the headphones (only when **[MASTER]** has been selected with the **HEADPHONES CUE** button); when rotated counterclockwise (toward **[CUE]**), the headphones output becomes the mixture of the effect monitor and the channel selected with the **HEADPHONES CUE** button.

In the middle position, the audio from **[MASTER]** and **[CUE]** will be output.

30 Headphones level adjust dial (LEVEL)

Adjusts the output level of the headphones jack. (adjustable range: -∞ to 0 dB)

NAMES AND FUNCTIONS OF PARTS

31 Headphones jack (PHONES)

Connect to headphones equipped with phone-type jack.

32 Beat select buttons (◀ BEAT ▶)

▶ (Beat up): Doubles the calculated BPM.

◀ (Beat down): Halves the calculated BPM.

(P. 18)

- Some effects can be set for "3/4".

With some effects, these are used for functions other than setting the beat.

33 MIDI ON/OFF button

Sets MIDI output function (not including timing lock) to ON/OFF.

When power is first turned ON, automatically defaults to OFF.

34 MIDI start/stop button (MIDI START/STOP)

Outputs START/STOP signal for MIDI control function (see P. 21).

When this control is enabled, the [MIDI START (STOP)] message appears for two seconds on the display.

MIDI SNAP SHOT:

When the MIDI START/STOP button is held depressed, a snapshot is sent to the external MIDI component.

35 BPM measuring mode button (AUTO)

Switches between the BPM measuring modes AUTO and TAP.

When [AUTO] indicator on the display is lighted, the BPM will be measured automatically.

36 TAP button

The BPM is calculated from the intervals at which the TAP button is struck. If the TAP button is pressed in the AUTO mode, the mode automatically switches to the TAP mode (manual input).

37 MANUAL/EFFECT Frequency filter button

Use to switch between manual filter and effect frequency filter.

When power is first turned ON, defaults to effect frequency filter and the button indicator lights. When manual filter is selected, the button indicator does not light.

38 Manual filter adjust dial (FREQUENCY)

Use to adjust the cutoff frequency of the selected filter.

39 Effect selector (DELAY, ECHO, TRANS, FILTER, FLANGER, PHASER, REVERB, ROBOT (ROBOT VOCODER), CRUSH, ROLL, REVERSE (REVERSE ROLL), UP (UP ROLL), DOWN (DOWN ROLL), SND/RTN (SEND/RETURN))

Use to select desired type of effect (P. 16).

When using an external effector connected to the SEND and RETURN connectors, set to the [SND/RTN] position.

40 Effect channel selector (1, 2, 3, 4, MIC, CF.A, CF.B, MASTER)

Use to select the channel to which effects are applied (P. 18).

When [MIC] is selected, effects are applied to both microphone 1 and microphone 2.

41 Effect parameter 1 dial [TIME (PARAMETER 1)]

Adjusts time parameter for selected effect (P. 18, 20) (With some effects, this is used for adjustments other than time parameters.)

- If the TIME dial is rotated while depressing the TAP button, direct BPM can be set manually.
- If the TIME dial is rotated while holding the TAP button and AUTO/TAP buttons depressed, the BPM can be set in 0.1 units.

42 Effect parameter 2 dial [LEVEL/DEPTH (PARAMETER 2)]

Adjusts quantitative parameters for selected effect (P. 18, 20).

43 Effect button/indicator (ON/OFF)

Sets selected effect ON/OFF (P. 18). When power is first turned ON, defaults to effect OFF. When set to effect OFF, the button indicator lights. When effects are enabled (ON), the button flashes.

44 Display

See the following section for details.

DISPLAY SECTION

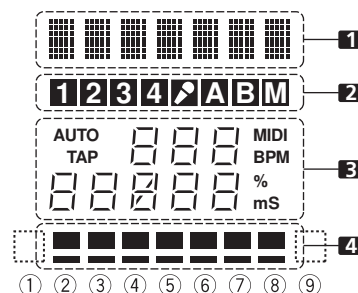

1 Effects display section

Text display (7 characters) displays effect name as shown in accompanying table. Also, when one of the change operations is performed as noted in the table, the corresponding characters are displayed for two seconds, after which the display returns to the original effect name.

Switching Operation	Display
At MIDI start	START
At MIDI stop	STOP
MIDI snapshot	SNAP
When MIDI output function is ON	MIDI On
When MIDI output function is OFF	MIDI Off

2 Channel select display section

Lights position selected by effect channel selector.

3 Parameter display section

AUTO/TAP:

[AUTO] lights when the BPM measuring mode is set to AUTO, and [TAP] lights when the BPM measuring mode is set to manual (TAP).

BPM counter display (3 digits):

In AUTO mode, displays the automatically detected BPM value. If the BPM count cannot be detected automatically, the display will flash at the previously detected value. In manual (TAP) mode, displays the BPM value designated by TAP input, etc.

BPM:

Lights constantly.

MIDI:

Indicates status of MIDI output function ON/OFF.

- Lights when MIDI output function is ON.
- Not lighted when MIDI output function is OFF.

Parameter 1 display (5 digits):

Displays parameters designated for each effect. When the beat select buttons (BEAT ◀, ▶) are pressed, the corresponding beat multiple change is displayed for two seconds. If the beat select buttons (BEAT ◀, ▶) are used to designate a value outside the parameter range, the current number will flash but will not change.

Unit Display (%/ms):

Lights in accordance with the unit used for each effect.

NAMES AND FUNCTIONS OF PARTS

4 Beat display section

Displays the location of parameter 1 relative to BPM (1/1 beat). The lower row is lighted constantly. When the parameter 1 location approaches a threshold value, the corresponding indicator is lighted. When the parameter 1 is between threshold values, the

indicator flashes. Although the display includes seven actual indicators, the values of the two ends can also be considered to represent indicators, with the result that nine positions can be logically assumed. When the values are at the two ends, no indicators light.

Effect selector	① Effect display	③ Parameter display				④ Beat display								
	Effect name	Minimum value	Maximum value	Default	Unit	①	②	③	④	⑤	⑥	⑦	⑧	⑨
DELAY	DELAY	1	4 000	500	ms	1/8	1/4	1/2	3/4	1/1	2/1	4/1	8/1	16/1
ECHO	ECHO	1	4 000	500	ms	1/8	1/4	1/2	3/4	1/1	2/1	4/1	8/1	16/1
TRANS	TRANS	10	16 000	500	ms	1/16	1/8	1/4	1/2	1/1	2/1	4/1	8/1	16/1
FILTER	FILTER	10	32 000	2 000	ms	1/4	1/2	1/1	2/1	4/1	8/1	16/1	32/1	64/1
FLANGER	FLANGER	10	32 000	2 000	ms	1/4	1/2	1/1	2/1	4/1	8/1	16/1	32/1	64/1
PHASER	PHASER	10	32 000	2 000	ms	1/4	1/2	1/1	2/1	4/1	8/1	16/1	32/1	64/1
REVERB	REVERB	1	100	50	%	10	20	30	40	50	60	70	80	90
ROBOT	ROBOT	-100	100	0	%	—	-100	-66	-50	0	26	50	100	—
CRUSH	CRUSH	10	32 000	2 000	ms	1/4	1/2	1/1	2/1	4/1	8/1	16/1	32/1	64/1
ROLL	ROLL	10	4 000	500	ms	1/16	1/8	1/4	1/2	1/1	2/1	4/1	8/1	16/1
REV ROLL	REVROLL	10	4 000	500	ms	1/16	1/8	1/4	1/2	1/1	2/1	4/1	8/1	16/1
UP ROLL	UP ROLL	10	4 000	500	ms	1/16	1/8	1/4	1/2	1/1	2/1	4/1	8/1	16/1
DOWN ROLL	DWNROLL	10	4 000	500	ms	1/16	1/8	1/4	1/2	1/1	2/1	4/1	8/1	16/1
SND/RTN	SND/RTN													

Shaded items  are not displayed.

MIXER OPERATIONS

BASIC OPERATIONS

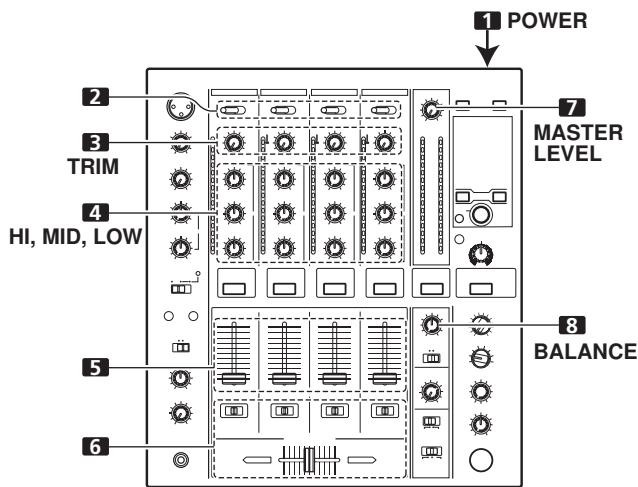

- 1 Set rear panel POWER switch to ON.
- 2 Set the input selector switch for the desired channel to choose the connected component.
 - CH1: Set to [CD] or [LINE].
 - CH2: Set to [CD] or [PHONO].
 - CH3/4: Set to [LINE] or [PHONO].
- 3 Use the TRIM dial to adjust the input level.
- 4 Use the channel equalizer dials (HI, MID, LOW) to adjust the tone.
- 5 Use the channel fader lever to adjust the sound volume of the selected channel.
- 6 To use the cross fader on the selected channel, set the CROSS FADER ASSIGN switch to either cross fader channel A or channel B, and operate the cross fader lever.
 - When not using the cross fader, set the CROSS FADER ASSIGN switch to [THRU].
- 7 Use the MASTER LEVEL dial to adjust the overall sound volume.
- 8 Use the BALANCE dial to adjust the sound balance between right and left.

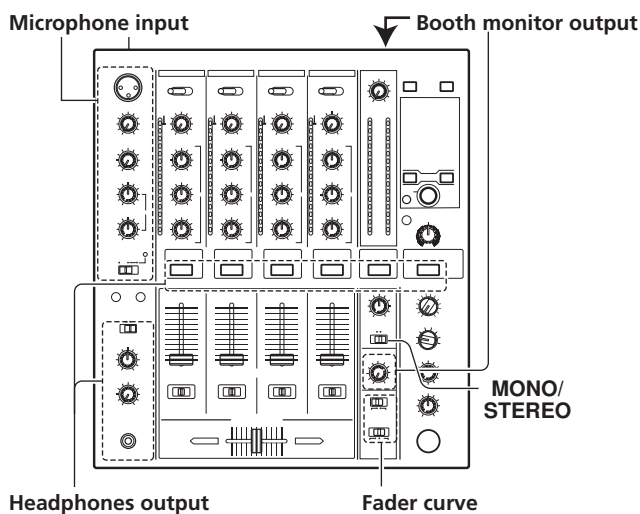

[Selecting Stereo or Monaural]

When the **MONO/STEREO** switch is set to [MONO], the master output becomes a monaural combination of L+R channels.

[Microphone Input]

- 1 To use a microphone, set the MIC switch to [ON] or [TALK OVER].
 - When the switch is set to [TALK OVER], any time a sound of over -15 dB is detected by the microphone, the output for all sound sources other than the microphone are attenuated by 20 dB.
- 2 Use the MIC 1 LEVEL dial to adjust the sound volume of MIC 1, and use the MIC 2 LEVEL dial to adjust the sound volume of MIC 2.
- 3 Use the microphone equalizer dials (HI, LOW) to adjust the tone of the microphone sound.
 - The microphone equalizer function operates simultaneously on microphone 1 and 2.

[Booth Monitor Output]

- 1 Use the BOOTH MONITOR LEVEL dial to adjust the sound volume.
 - The BOOTH MONITOR LEVEL dial can be used to adjust the sound volume independently of the MASTER LEVEL dial.

[Headphones Output]

- 1 Use the HEADPHONES CUE buttons (channels 1 to 4, MASTER, EFFECTS) to select the source.
 - The selected HEADPHONES CUE button lights brightly.
- 2 Set the headphones (MONO SPLIT/STEREO) switch.
 - When HEADPHONES CUE (1, 2, 3, 4 or EFFECTS) button is selected, the selected audio is output to the L channel. When HEADPHONES CUE (MASTER) button is selected, the master audio is output from the R channel.
 - When set to the [STEREO] position, the sound corresponding to the selected HEADPHONES CUE button is output in stereo.
- 3 When [MONO SPLIT] is selected, use the MIXING dial to adjust the balance of sound between the left channel (sound selected with the HEADPHONES CUE button), and the right channel (the master sound – but only when the HEADPHONES CUE button for the [MASTER] is ON).
 - When the MIXING dial is rotated clockwise (toward [MASTER]), the master output (only when the HEADPHONES CUE button for the [MASTER] is ON) increases; when rotated counterclockwise (toward [CUE]), the sound selected with the HEADPHONES CUE button is output.
- 4 Use the LEVEL dial to adjust the headphones' sound volume.

MIXER OPERATIONS

[Fader Curve Selection]

Select sound-volume curve corresponding to fader operation.

Use the CH FADER switch to select the desired channel fader response curve.

- At the left setting, the curve operates to produce a rapid rise as the channel fader approaches its distant position.
- At the right setting, the curve operates to produce an even, neutral rise throughout the channel fader's movement.
- This setting applies equally to channels 1 to 4.

Use the CROSS FADER curve switch to select the cross fader curve response.

- At the left setting, the curve produces a rapid signal rise. (As soon as the cross fader lever leaves the [A] side, the [B] channel sound is produced.)
- At the right setting, the curve operates to produce an even, neutral rise throughout the cross fader's movement.
- At the middle setting, an intermediate curve is produced, midway between the two curves noted above.
- This setting produces equal curve effects for both sides A and B.

FADER START FUNCTION

By connecting the optional Pioneer DJ CD Player control cable, the channel fader and cross fader can be used to start CD playback.

When the mixer's channel fader lever or cross fader lever are moved, the CD player is released from the pause mode and automatically –and instantly – begins playback of the selected track. Also, when the fader lever is returned to its original position, the CD player returns to its cue point (back cue), thus allowing "sampler" type play.

Cross fader start play and back cue play

When the CD player assigned to cross fader channel A is set to standby at a cue point, moving the cross fader lever from the right (B) side toward the left (A) side automatically starts play on the channel A CD player.

When the cross fader lever reaches the left (A) side, the CD player assigned to channel B goes to back cue (returns to cue point).

Also, when the CD player assigned to channel B is set to standby at a cue point, moving the cross fader lever from the left (A) side to the right (B) side automatically starts playback on the channel B CD player. When the cross fader lever reaches the right (B) side, the CD player assigned to channel A goes to back cue (returns to cue point).

- The back cue is performed even if the input selector switch is not set to [CD] or [LINE].

[Using the Channel Fader to Start Playback]

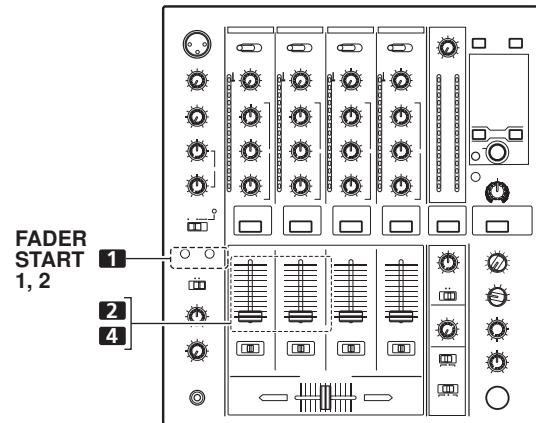

- 1 **Press the FADER START button for the channel (1, 2) connected to the CD player you wish to control.**
 - The button for the selected channel lights.
 - 2 **Set the channel fader lever to "0".**
 - 3 **Set the CD player to the desired cue point, and engage cue point standby.**
 - If a cue point has already been set, it is not necessary to set the CD player to standby at the cue point.
 - 4 **At the instant you wish to start playback, move the channel fader lever.**
 - CD player begins playback.
 - After playback has begun, if the channel fader lever is returned to the [0] position, the CD player returns to the cue point and re-enters standby mode (back cue).
- Playback control is possible with the channel fader only with the **CROSS FADER ASSIGN** switch is set to [THRU].

MIXER OPERATIONS

[Using the Cross Fader to Start Playback]

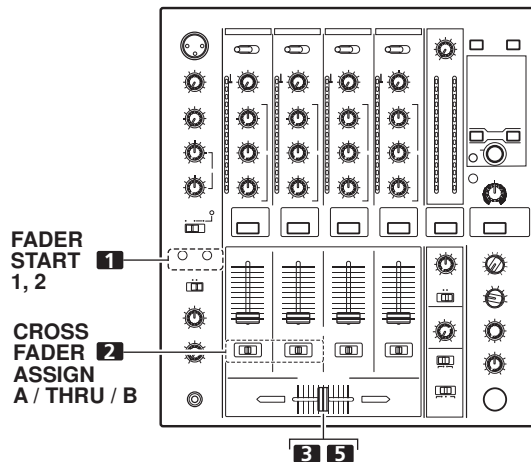

- 1 Press the FADER START button for the channel (1, 2) connected to the CD player you wish to control.**
 - The button for the selected channel lights.
- 2 Set the CROSS FADER ASSIGN switch for the selected channel to [A] or [B].**
 - Select [A] to assign to cross fader channel A (left side).
 - Select [B] to assign to cross fader channel B (right side).
- 3 Move the cross fader lever to the full opposite side away from the CD player you wish to start.**
- 4 Set the CD player to the desired cue point, and engage cue point standby.**
 - If a cue point has already been set, it is not necessary to set the CD player to standby at the cue point.
- 5 At the instant you wish to start playback, move the cross fader lever.**
 - CD player begins playback.
 - After playback has begun, if the cross fader lever is moved fully to the opposite side, the CD player assigned to the opposite side channel will return to the cue point and enter standby mode (back cue).

EFFECT FUNCTIONS

This unit can produce a total of 15 basic beat effects (including SND/RTN) through beat effects linked to the BPM and manual filters or effect frequency filters linked to the **FREQUENCY** dial. Additionally, by adjusting the parameters for each effects, a wide range of effects can be produced.

A wide variety of beat effects can be created by adjusting the temporal parameter through the **TIME** dial (Parameter 1) as well as the quantitative parameter through the **LEVEL/DEPTH** dial (Parameter 2).

A low-pass filter effect or high-pass filter effect can be created with the manual filter or effect frequency filter depending on the positioning of the **FREQUENCY** dial. Additionally, by combining beat effects with the manual filter or effect frequency filter, a wide range of effects can be created.

TYPES OF BEAT EFFECTS

1 DELAY (One repeat sound)

This function allows a delay sound with beat of 1/8, 1/4, 1/2, 3/4, 1/1, 2/1, 4/1, 8/1, or 16/1 to be added quickly and simply. For example, When a 1/2 beat delay sound is added, four beats become eight beats. Also, by adding a 3/4 beat delay sound, the rhythm becomes syncopated.

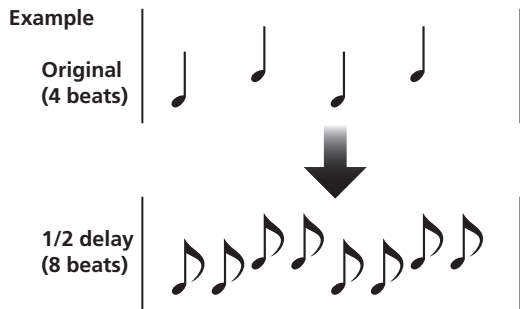

2 ECHO (Multiple repeat sounds)

This function allows an echo sound with beat of 1/8, 1/4, 1/2, 3/4, 1/1, 2/1, 4/1, 8/1, or 16/1 to be added quickly and simply. For example, when a 1/1 beat echo sound is used to cutoff the input sound, a sound in synch with the beat is repeated together with fadeout.

Also, by adding a 1/1 beat echo to the microphone, the microphone sound repeats in synch with the music beat. If a 1/1 beat echo is applied to the vocal portion of a track, the song takes on an effect reminiscent of a "round".

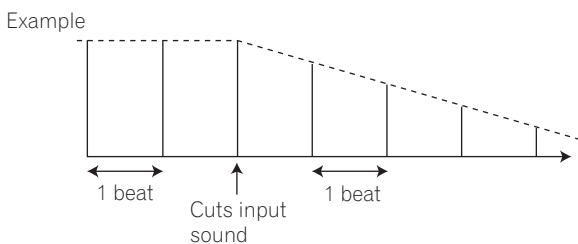

3 Auto TRANS

In units of 1/16, 1/8, 1/4, 1/2, 1/1, 2/1, 4/1, 8/1, or 16/1 beat, the sound is automatically cut in synch with the rhythm.

Example

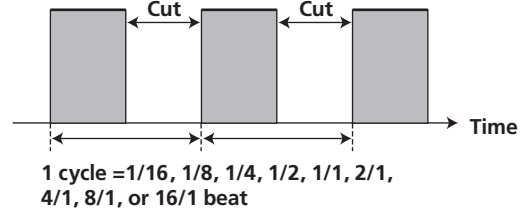

4 FILTER

In units of 1/4, 1/2, 1/1, 2/1, 4/1, 8/1, 16/1, 32/1, or 64/1 beat, the filter frequency is moved, greatly changing the sound coloration.

Example

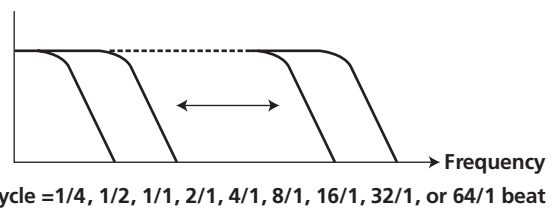

5 FLANGER

In units of 1/4, 1/2, 1/1, 2/1, 4/1, 8/1, 16/1, 32/1, or 64/1 beat, 1 cycle of flanger effect is produced quickly and easily.

Example

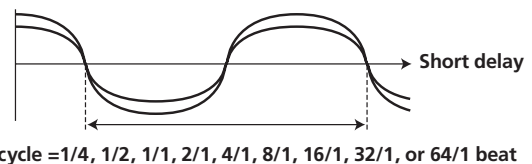

6 PHASER

In units of 1/4, 1/2, 1/1, 2/1, 4/1, 8/1, 16/1, 32/1, or 64/1 beat, 1 cycle of phaser effect is produced quickly and easily.

Example

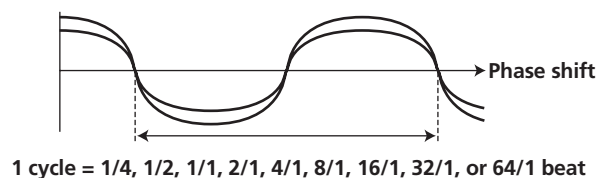

EFFECT FUNCTIONS

7 REVERB

Produces reverberation effect.

8 ROBOT

Generates sound effect resembling that produced by a robot. When ROBOT is applied to microphone sound, a voice-changer effect is produced.

9 CRUSH

Allows rapid creation of cyclically changing "crush sound effect" in beats of 1/4, 1/2, 1/1, 2/1, 4/1, 8/1, 16/1, 32/1, or 64/1.

Example

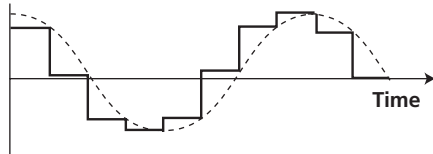

1 cycle = 1/4, 1/2, 1/1, 2/1, 4/1, 8/1, 16/1, 32/1, or 64/1 beat

10 ROLL

Records sounds at 1/16, 1/8, 1/4, 1/2, 1/1, 2/1, 4/1, 8/1, 16/1 beats and plays them repeatedly.

Example

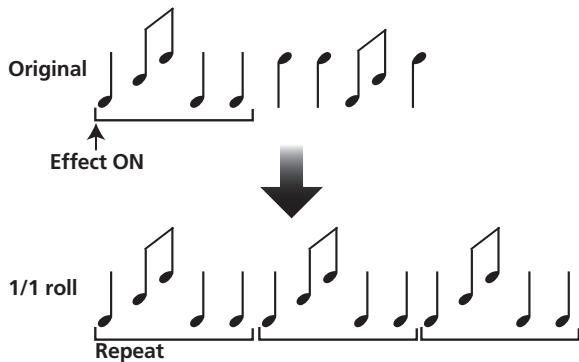

11 REVERSE ROLL

Records sounds at 1/16, 1/8, 1/4, 1/2, 1/1, 2/1, 4/1, 8/1, 16/1 beats and repeats them but in reverse order.

Example

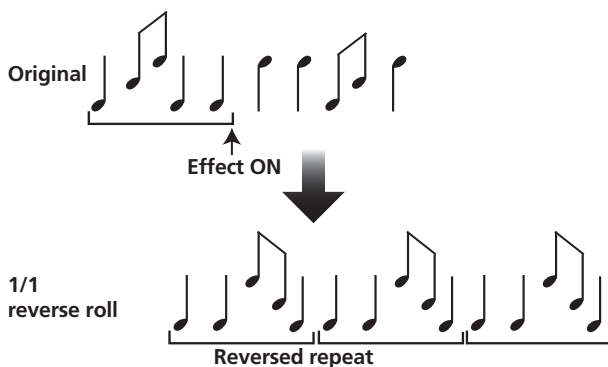

12 UP ROLL

Records sounds at 1/16, 1/8, 1/4, 1/2, 1/1, 2/1, 4/1, 8/1, 16/1 beats, and plays them repeatedly while continuously raising their pitch/key.

Example

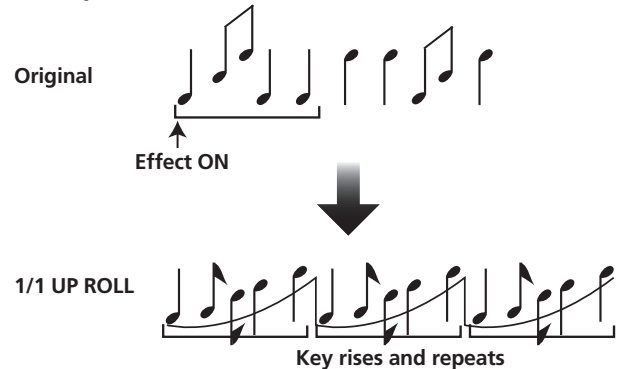

13 DOWN ROLL

Records sounds at 1/16, 1/8, 1/4, 1/2, 1/1, 2/1, 4/1, 8/1, 16/1 beats, and plays them repeatedly while continuously lowering their pitch/key.

Example

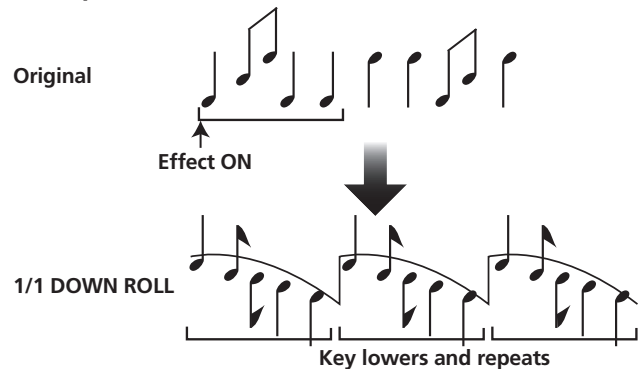

14 SEND/RETURN

By connecting a sampler or effector, a wide variety of other effects can be created.

PRODUCING BEAT EFFECTS

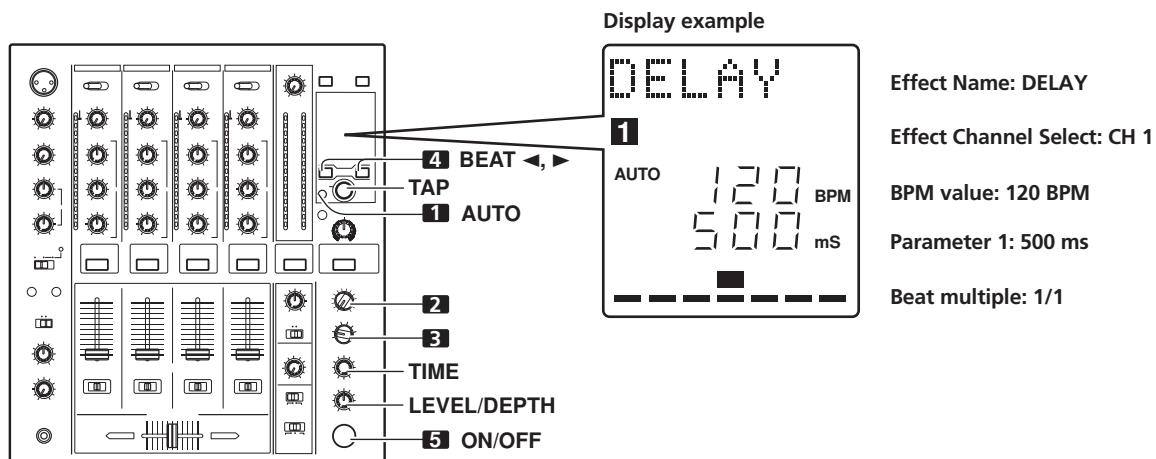

Beat effects allow the instant setting of effect times in synch with the BPM (beats per minute), thus allowing the production of a wide variety of effects in synch with the current rhythm, even during live performances.

1 Set BPM measuring mode to AUTO to measure BPM (beats per minute).

The BPM of the input music signal is detected automatically. Whenever power is first turned ON, the function defaults to the [AUTO] mode.

- In the event the track's BPM cannot be detected automatically, the display's BPM counter will flash.
- Measurable range: BPM=70 to 180.

It may not be possible to measure some tracks accurately.

In this case, press the **TAP** button and input the beat manually.

[Using the TAP Button for Manual BPM Input]

If the **TAP** button is tapped two times or more in synch with beat (1/4 notes), the BPM will be recorded as the average value recorded during that interval.

- When BPM mode is set to [AUTO], tapping the **TAP** button will cause the BPM mode to change to the TAP mode, and the interval at which the **TAP** button is pressed will be measured.
- When the BPM is set via the **TAP** button, the beat multiple becomes "1/1" (or "4/1", depending on the effect selected), and the time for 1 beat (1/4 notes) or 4 beats will be set as the effect time.
- If the **TIME** dial is rotated while depressing the **TAP** button, direct BPM can be set manually.
If the **TIME** dial is rotated while holding the **TAP** button and **AUTO** buttons depressed, the BPM can be set in 0.1 units.

2 Set the effect selector to the desired effect.

- The display will show the name of the selected effect.
- See P. 16 to 17 for details regarding the various effects.

3 Set the effect channel selector to the channel you wish to apply the effect to.

- The selected channel lights in the display's channel name area.
- If [MIC] is selected, the effect will be applied to both microphone 1 and microphone 2.

4 Press the BEAT button (◀, ▶) to select the beat multiple to which the effect is to be synchronized.

- When ▶ is pressed, the beat count calculated from the BPM is doubled, and when ◀ is pressed, the beat count calculated from the BPM is halved (some effects also allow "3/4" setting).
- The multiple of the selected beat (parameter 1 position) is displayed in seven sections on the display (see P. 12).
- The effect time corresponding to the beat's multiple is set automatically.

Example: When BPM = 120

1/1 = 500 ms

1/2 = 250 ms

2/1 = 1 000 ms

5 Set the ON/OFF button to ON to enable the effect.

- Each time the button is pressed, the effect alternates ON/OFF (whenever power is first turned ON, the function defaults to OFF).
- The **ON/OFF** button flashes when the effect is ON.

Parameter 1

Rotating the **TIME (PARAMETER 1)** dial adjusts the temporal parameter (time) for the selected effect. (With some effects, this is used for adjustments other than time parameters.) See P. 20 for details regarding the effect on parameter 1 of rotating the **TIME (PARAMETER 1)** dial.

Parameter 2

Rotating the **LEVEL/DEPTH (PARAMETER 2)** dial adjusts the quantitative parameter for the selected effect. See P. 20 for details regarding the effect on parameter 2 of rotating the **LEVEL/DEPTH (PARAMETER 2)** dial.

MANUAL FILTER OPERATION

1 MANUAL FILTER

The filter frequency is shifted, resulting in strong changes to the tone.
Rotating the dial to the right produces high-pass filter effects, while rotating the dial to the left produces low-pass filter effects.

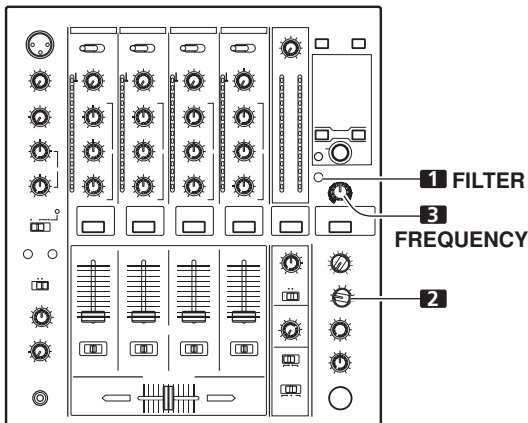
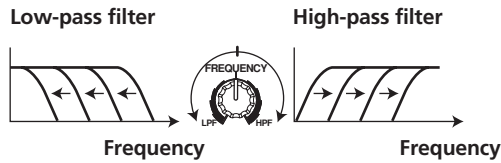

The manual effector is linked to the **FREQUENCY** dial. The output sounds of the manual effector become the input sounds for the beat effect.

- When the beat effect type is set to ROLL, REVERSE ROLL, UP ROLL, or DOWN ROLL, the beat effect's output sound becomes the input sound for the manual effector.
- 1 Press the FILTER button so that it flashes.**
 - Confirm that the **FILTER** button flashes steadily.
 - When it lights, press the button so that it flashes. Each time the button is pressed, it alternates between flashing and lighting steadily.
 - When power is first turned ON, defaults to steadily lighted.
 - 2 Use the effect channel select switch to choose the channel to which you wish to apply the effects.**
 - The name of the selected channel will appear in the display's channel name section.
 - When [MIC] is selected, the effect will be applied to both microphone 1 and microphone 2.
 - 3 Use the FREQUENCY dial to adjust the filter's cutoff frequency.**
 - Rotate counterclockwise to apply a low-pass filter.
 - Rotate clockwise to apply a high-pass filter.

EFFECT FREQUENCY FILTER OPERATION

1 Effect frequency filter

Sets the filter's cutoff frequency, allowing the beat effect to be applied to a desired frequency band alone.

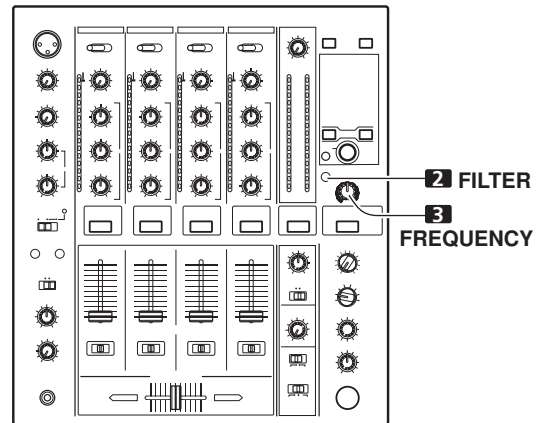
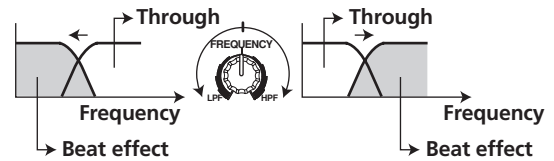

The effect frequency filter is linked to the **FREQUENCY** dial. The beat effect is applied only to the selected frequency band.

- The function is not supported when SEND/RETURN is selected as the type of beat effect.
- 1 Press the FILTER button so that it lights.**
 - Confirm that the **FILTER** button lights steadily.
 - When flashing, press the button so that it lights. Each time the button is pressed, it alternates between flashing and lighting steadily.
 - When power is first turned ON, defaults to steadily lighted.
 - 2 Operate the beat effect.**
 - For details, see page 18.
 - 3 Use the FREQUENCY dial to select the frequency to which you wish to apply the beat effect.**
 - Rotate counterclockwise to apply the effect to low-range sounds only. High-frequency sounds are set to through.
 - Rotate clockwise to apply the effect to high-range sounds only. Low-frequency sounds are set to through.

EFFECT FUNCTIONS

EFFECT PARAMETERS

Beat Effect (*1)

Name	Beat Switch Parameter	Parameter 1 (TIME dial)		Parameter 2 (LEVEL/DEPTH dial) contents
		Contents	Setting Range (unit)	
1 DELAY	Sets delay time of 1/8 to 16/1 per 1 beat of BPM time.	Sets delay time.	1 to 4 000 (ms)	Sets balance between original and delay sound.
2 ECHO (*2)	Sets delay time of 1/8 to 16/1 per 1 beat of BPM time.	Sets delay time.	1 to 4 000 (ms)	Sets balance between original sound and echo sound.
3 TRANS	Sets cut time of 1/16 to 16/1 per 1 beat of BPM time.	Sets effect time.	10 to 16 000 (ms)	Sets balance between original sound and effect sound.
4 FILTER	Cycle of cutoff frequency shift is set in unit of 1/4 to 64/1 relative to 1 beat of BPM.	Sets cycle for cutoff time shift.	10 to 32 000 (ms)	Amount of effect increases when dial is turned clockwise.
5 FLANGER	Cycle of flanger shift is set in units of 1/4 to 64/1 relative to 1 beat of BPM.	Sets cycle for flanger effect shift.	10 to 32 000 (ms)	Amount of effect increases when dial is turned clockwise. When dial is turned fully counterclockwise, only original sound is output.
6 PHASER	Cycle of phaser effect shift is set in units of 1/4 to 64/1 relative to 1 beat of BPM.	Sets cycle for phase effect shift.	10 to 32 000 (ms)	Amount of effect increases when dial is turned clockwise. When dial is turned fully counterclockwise, only original sound is output.
7 REVERB (*2)	Amount of reverberation is set from 1 % to 100 %.	Sets amount of reverberation effect.	1 to 100 (%)	Sets balance between original sound and effect sound.
8 ROBOT	Sets pitch of robot sound effect within range of -100 % to +100 %.	Sets pitch of robot sound effect.	-100 to +100 (%)	Amount of effect increases when dial is turned clockwise.
9 CRUSH	Cycle of crush effect movement is set to 1/4 to 64/1 relative to a single beat of BPM.	Sets cycle for crush effect shift.	10 to 32 000 (ms)	Amount of effect increases when dial is turned clockwise. When dial is turned fully counterclockwise, only original sound is output.
10 ROLL (*2)	Effect time is set as 1/16 to 16/1 relative of 1 beat of BPM.	Sets effect time.	1 to 4 000 (ms)	Sets balance of original sound and roll sound.
11 REVERSE ROLL (*2)	Effect time is set as 1/16 to 16/1 relative of 1 beat of BPM.	Sets effect time.	1 to 4 000 (ms)	Sets balance of original sound and roll sound.
12 UP ROLL (*2)	Effect time is set as 1/16 to 16/1 relative of 1 beat of BPM.	Sets effect time.	1 to 4 000 (ms)	Sets balance of original sound and roll sound.
13 DOWN ROLL (*2)	Effect time is set as 1/16 to 16/1 relative of 1 beat of BPM.	Sets effect time.	1 to 4 000 (ms)	Sets balance of original sound and roll sound.
14 SEND/ RETURN	—	—	—	Sets volume of RETURN input sound.

(*1) When the effect channel selector is set to [CF.A], [CF.B], or [MASTER], even if the effect monitor is turned ON, if the selected channel's sound is not output to the master output, the effect sound will not be heard.

(*2) When effect is disabled (OFF), the effect sound will not be heard, even if monitor is set to effector.

MIDI SETTINGS

MIDI is an acronym for “Musical Instrument Digital Interface” and refers to a protocol developed for the exchange of data between electronic instruments and computers. A MIDI cable is used to connect components equipped with MIDI connectors to enable the transmission and receipt of data. The DJM-700-S/DJM-700-K uses the MIDI protocol for transmitting data about component operation and BPM (timing clock).

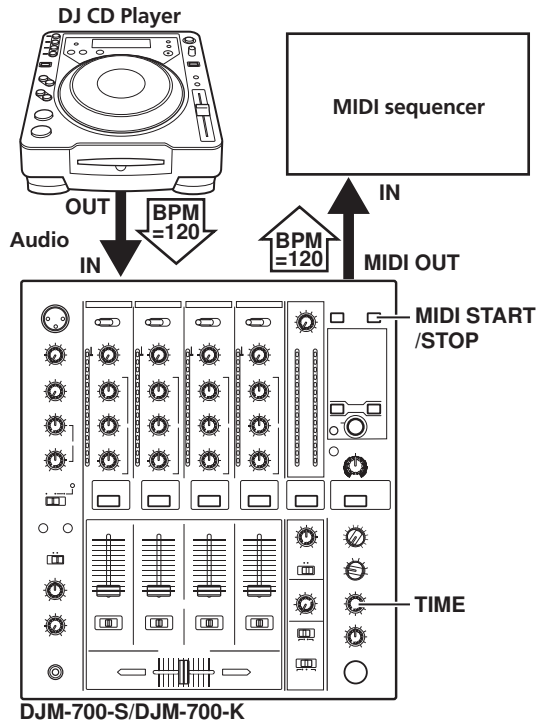

SYNCHRONIZING AUDIO SIGNALS TO EXTERNAL SEQUENCER, OR USING DJM-700-S/DJM-700-K INFORMATION TO OPERATE AN EXTERNAL SEQUENCER

- 1 Use a commercially available MIDI cable to connect the DJM-700-S/DJM-700-K's MIDI OUT connector to the MIDI sequencer's MIDI IN connector.
 - Set the MIDI sequencer's synch mode to "Slave".
 - MIDI sequencers that do not support MIDI timing clock cannot be synchronized.
 - Synch may not be achieved if the track's BPM cannot be detected and measured stably.
 - BPM values set with the TAP mode can also be used to output the timing clock.
- 2 Press the MIDI START/STOP button.
 - The MIDI timing clock output range is 40 to 250 BPM.

[MIDI Channel Setting]

The MIDI channel (1 to 16) can be set and stored in memory.

- 1 While holding the MIDI START/STOP button depressed, set the power switch to ON.
 - The display will show [CH SET] and the unit will enter the MIDI setting mode.
- 2 Rotate the TIME dial to select the MIDI channel.
- 3 Press the MIDI START/STOP button.
 - Records MIDI channel. During recording of channel, [SAVE] indicator flashes.
 - When recording of channel is completed, [END] is displayed.
- 4 Set power to OFF.

MIDI SETTINGS

MIDI MESSAGES

Category	Switch Name	Switch Type	MIDI Message						Comments
			MSB			LSB			
CH1	HI	VR	Bn	02	dd				0 to 127
	MID	VR	Bn	03	dd				0 to 127
	LOW	VR	Bn	04	dd				0 to 127
	CUE	BUTTON	Bn	46	dd				OFF=0, ON=127
	FADER	VR	Bn	11	dd				0 to 127
	CF ASSIGN	SW	Bn	41	dd				0, 64, 127
CH2	HI	VR	Bn	07	dd				0 to 127
	MID	VR	Bn	08	dd				0 to 127
	LOW	VR	Bn	09	dd				0 to 127
	CUE	BUTTON	Bn	47	dd				OFF=0, ON=127
	FADER	VR	Bn	12	dd				0 to 127
	CF ASSIGN	SW	Bn	42	dd				0, 64, 127
CH3	HI	VR	Bn	0E	dd				0 to 127
	MID	VR	Bn	0F	dd				0 to 127
	LOW	VR	Bn	15	dd				0 to 127
	CUE	BUTTON	Bn	48	dd				OFF=0, ON=127
	FADER	VR	Bn	13	dd				0 to 127
	CF ASSIGN	SW	Bn	43	dd				0, 64, 127
CH4	HI	VR	Bn	51	dd				0 to 127
	MID	VR	Bn	5C	dd				0 to 127
	LOW	VR	Bn	52	dd				0 to 127
	CUE	BUTTON	Bn	49	dd				OFF=0, ON=127
	FADER	VR	Bn	14	dd				0 to 127
	CF ASSIGN	SW	Bn	44	dd				0, 64, 127
CROSS FADER	CROSS FADER	VR	Bn	0B	dd				0 to 127
FADER CURVE	CH CURVE	SW	Bn	5E	dd				0, 127
	CROSS CURVE	SW	Bn	5F	dd				0, 64, 127
MASTER	MASTER LEVEL	VR	Bn	18	dd				0 to 127
	BALANCE	VR	Bn	17	dd				0 to 127
	CUE	BUTTON	Bn	4A	dd				OFF=0, ON=127
BOOTH	MONITOR	VR	Bn	19	dd				0 to 127
FILTER	FILTER	BUTTON	Bn	54	dd				OFF=0, ON=127
	FREQUENCY	VR	Bn	05	dd				0 to 127

MIDI SETTINGS

Category	Switch Name	Switch Type	MIDI Message						Comments
			MSB			LSB			
EFFECT	BEAT LEFT	BUTTON	Bn	4C	dd				OFF=0, ON=127
	BEAT RIGHT	BUTTON	Bn	4D	dd				OFF=0, ON=127
	AUTO/TAP	BUTTON	Bn	45	dd				OFF=0, ON=127
	TAP	BUTTON	Bn	4E	dd				OFF=0, ON=127
	CUE	BUTTON	Bn	4B	dd				OFF=0, ON=127
	EFFECT KIND	SW	Cn	pc					See "PROGRAM CHANGE" below.
	CH SELECT	SW	Cn	pc					See "PROGRAM CHANGE" below.
	TIME	SW	Bn	0D	MSB	Bn	2D	LSB	PARAMETER 1 value; FLANGER, PHASER, FILTER, CRUSH changed to 1/2 value; minus values are converted to positive.
	LEVEL/DEPTH	VR	Bn	5B	dd				0 to 127
	EFFECT ON/OFF	BUTTON	Bn	40	dd				OFF=0, ON=127
MIC	HI	VR	Bn	1E	dd				0 to 127
	LOW	VR	Bn	1F	dd				0 to 127
(FADER START)	FADER START 1	BUTTON	Bn	58	dd				OFF=0, ON=127
	FADER START 2	BUTTON	Bn	59	dd				OFF=0, ON=127
(HEAD PHONES)	MIXING	VR	Bn	1B	dd				0 to 127
	LEVEL	VR	Bn	1A	dd				0 to 127
MIDI	START	BUTTON	FA						
	STOP	BUTTON	FC						

MIDI SETTINGS

PROGRAM CHANGE

MSB			LSB				
0	0	EFFSEL2	EFFSEL1	EFFSEL0	EFFCH2	EFFCH1	EFFCH0

• EFFECT SEL			BEAT
EFFSEL2	EFFSEL1	EFFSEL0	
0	0	1	DELAY
0	1	0	ECHO
1	0	0	TRANS
1	1	0	FILTER
1	0	1	FLANGER
1	1	1	PHASER
0	1	1	REVERB
—	—	—	ROBOT
—	—	—	CRUSH
—	—	—	ROLL
—	—	—	REV ROLL
—	—	—	UP ROLL
—	—	—	DWNROLL
—	—	—	SND/RTN
0	0	1	1
0	1	0	2
0	1	1	3
1	0	0	4
1	0	1	MIC
1	1	0	CF.A
1	1	1	CF.B
—	—	—	MASTER

SNAPSHOT

Once the DJM-700-S/DJM-700-K is setup with parameters for a given purpose, that set of parameters can be recorded as a snapshot. When snapshot of the current status is recorded, all messages for control change and program change are transmitted. Hold the **MIDI START/STOP** button depressed to send the snapshot.

MIDI ON/OFF

Use the **MIDI ON/OFF** button to control whether the MIDI control signal is generated. The default condition is MIDI OFF. Even when MIDI OFF is selected, however, timing clock and snap shot functions are supported.

TROUBLESHOOTING

Incorrect operations are often mistaken for trouble and malfunctions. If you think there is something wrong with this component, check the points below. Sometimes the trouble may originate from another component. Thus, also check the other electrical appliances also in use.

If the trouble cannot be rectified even after checking the following items, contact your dealer or nearest PIONEER service center.

Symptom	Possible Cause	Remedy
No power	<ul style="list-style-type: none"> The power cord has not been connected. 	<ul style="list-style-type: none"> Connect to power outlet.
No sound, or sound volume is too low.	<ul style="list-style-type: none"> Input selector is set incorrectly. Connection cables are connected incorrectly, or connections are loose. Jacks or plugs are dirty. The rear panel master output attenuator switch (MASTER ATT) is set to -6 dB, etc. 	<ul style="list-style-type: none"> Set input selector to playback component. Connect correctly. Clean soiled jacks/plugs before connecting. Adjust rear panel master attenuator switch (MASTER ATT).
No digital output.	<ul style="list-style-type: none"> The digital output sampling frequency (fs) does not match the specifications of the connected component. 	<ul style="list-style-type: none"> Set rear panel sampling frequency selector to match the specifications of the connected component.
Sound is distorted.	<ul style="list-style-type: none"> Master output level is too high. Input level is too high. 	<ul style="list-style-type: none"> Adjust master output level (MASTER LEVEL) dial or the rear panel master output attenuator (MASTER ATT) switch. Adjust the TRIM dial so that the input level approaches 0 dB on the channel level indicator.
Cross fader doesn't work.	<ul style="list-style-type: none"> CROSS FADER ASSIGN switch setting ([A], [THRU], [B]) is incorrect. 	<ul style="list-style-type: none"> Correctly set the CROSS FADER ASSIGN switch for the desired channel.
Can't perform fader start with CD player.	<ul style="list-style-type: none"> The FADER START button is set to OFF. Rear panel CONTROL jack is not connected to CD player. Only the rear panel CONTROL jack is connected to the CD player. 	<ul style="list-style-type: none"> Set the FADER START button to ON. Use a control cable to connect the CONTROL jacks of mixer and CD player. Connect both the CONTROL jacks and analog input connectors.
Effects don't work.	<ul style="list-style-type: none"> Effect channel selector setting is incorrect. Effect parameter 2 adjust dial (LEVEL/DEPTH) is set to [MIN]. 	<ul style="list-style-type: none"> Correctly select the channel on which you wish to apply effects. Adjust the effect parameter 2 adjust dial (LEVEL/DEPTH).
External effector doesn't work.	<ul style="list-style-type: none"> Effect selector is not set to [SND/RTN]. Effector is not connected to rear panel SEND/RETURN connector. Effect channel selector is set to incorrectly. 	<ul style="list-style-type: none"> Set effect selector to [SND/RTN]. Connect effector to the rear panel SEND/RETURN connectors. Use the effect channel selector to select the audio source to which you wish to apply the effects.
Sound from external effector is distorted.	<ul style="list-style-type: none"> Input level from external effector is set too high. 	<ul style="list-style-type: none"> Lower the output level of the external effector.
BPM can't be measured. Measured BPM value is incorrect.	<ul style="list-style-type: none"> Input level is too high, or too low. BPM may not be correctly measurable with some tracks. 	<ul style="list-style-type: none"> Adjust the TRIM dial so that the input level approaches 0 dB in the channel level indicator. Adjust other channels as well so that the input levels approach 0 dB in the channel level indicator. Strike the TAP button to set BPM manually.
The measured BPM value is different from the value published with the CD.	<ul style="list-style-type: none"> Some differences may occur due to differences in BPM detection methods. 	<ul style="list-style-type: none"> No remedy is necessary.
MIDI sequencer can't be synchronized.	<ul style="list-style-type: none"> MIDI sequencer's synch mode is not set to "slave". MIDI sequencer is not supported type. 	<ul style="list-style-type: none"> Set MIDI sequencer's sync mode to "slave". MIDI sequencers that do not support MIDI timing clock cannot be synchronized.

Static electricity or other external interference may cause the unit to malfunction. To restore normal operation, turn the power off and then on again.

SPECIFICATIONS

1 General

Power source AC 120 V, 60 Hz
 Power consumption 34 W
 Operating temperature +5 °C to +35 °C (+41 °F to +95 °F)
 Operating humidity 5 % to 85 % (without condensation)
 Weight 6.6 kg (14.6 lb)
 Maximum dimensions
 320 mm (W) x 378.4 mm(D) x 107.9 mm (H)
 12.6 in (W) x 15.3 in (D) x 4.3 in (H)

2 Audio section

Sampling rate 96 kHz
 A/D, D/A converter 24 bits
 Frequency response
 LINE 20 Hz to 20 kHz
 MIC 20 Hz to 20 kHz
 PHONO 20 Hz to 20 kHz (RIAA)
 S/N ratio (at rated output)
 LINE 104 dB
 PHONO 94 dB
 MIC 82 dB
 Distortion (LINE-MASTER 1) 0.005 %
 Standard input level/Input impedance
 PHONO 2 to 4 -52 dBu/47 kΩ
 MIC 1 -52 dBu/22 kΩ
 LINE, LINE/CD 1 to 4 -12 dBu/22 kΩ
 RETURN -12 dBu/47 kΩ
 Standard output level/Load impedance/Output impedance
 MASTER 1 +8 dBu/10 kΩ/22 Ω or less
 MASTER 2 +2 dBu/10 kΩ/10 Ω
 REC -8 dBu/10 kΩ/10 Ω
 BOOTH +2 dBu/10 kΩ/22 Ω
 SEND -12 dBu/10 kΩ/1 kΩ
 PHONES +8.5 dBu/32 Ω/22 Ω or less
 Rated output level/Load impedance
 MASTER 1 +25 dBu/10 kΩ
 MASTER 2 +20 dBu/10 kΩ
 Crosstalk (LINE) 82 dB
 Channel equalizer response
 HI -26 dB to +6 dB (13 kHz)
 MID -26 dB to +6 dB (1 kHz)
 LOW -26 dB to +6 dB (70 Hz)
 Microphone equalizer response
 HI -12 dB to +12 dB (10 kHz)
 LOW -12 dB to +12 dB (100 Hz)

3 Input/output connector systems

PHONO input connectors
 RCA pin jacks 3
 CD input connectors
 RCA pin jacks 2
 LINE input connectors
 RCA pin jacks 3
 MIC input connectors
 XLR connector 1
 Phone jack (Ø6.3 mm) 1
 RETURN input connectors
 Phone jacks (Ø6.3 mm) 1
 MASTER output connectors
 XLR connectors 1
 RCA pin jacks 1
 BOOTH output connectors
 RCA pin jacks 1
 REC output connectors
 RCA pin jacks 1
 SEND output connectors
 Phone jacks (Ø6.3 mm) 1
 DIGITAL coaxial output connector
 RCA pin jack 1
 MIDI OUT connector
 5P DIN 1
 PHONES output connector
 Stereo phone jack (Ø6.3 mm) 1
 CONTROL connector
 Mini phone jacks (Ø3.5 mm) 2

4 Accessories

Operating Instructions 1
 Warranty card 1

Specifications and appearance are subject to change without notice.

Should this product require service in the U.S.A. and you wish to locate the nearest Pioneer Authorized Independent Service Company, or if you wish to purchase replacement parts, operating instructions, service manuals, or accessories, please call the number shown below.

800 – 782 – 7210

Please do not ship your product to Pioneer without first calling the Customer Support Division at the above listed number for assistance.

**PIONEER ELECTRONICS (USA), INC.
 CUSTOMER SUPPORT DIVISION
 P.O. BOX 1760, LONG BEACH,
 CA 90801-1760, U.S.A.**

For warranty information please see the Limited Warranty sheet included with your product.

Should this product require service in Canada, please contact a Pioneer Canadian Authorized Dealer to locate the nearest Pioneer Authorized Service Company in Canada.

Alternatively, please contact the Customer Service Department at the following address:

Pioneer Electronics of Canada, Inc.

**300 Allstate Parkway
 Markham, ON L3R 0P2
 (905) 479-4411
 1 (877) 283-5901**

For warranty information please see the Limited Warranty sheet included with your product.

BLOCK DIAGRAM

BLOCK DIAGRAM

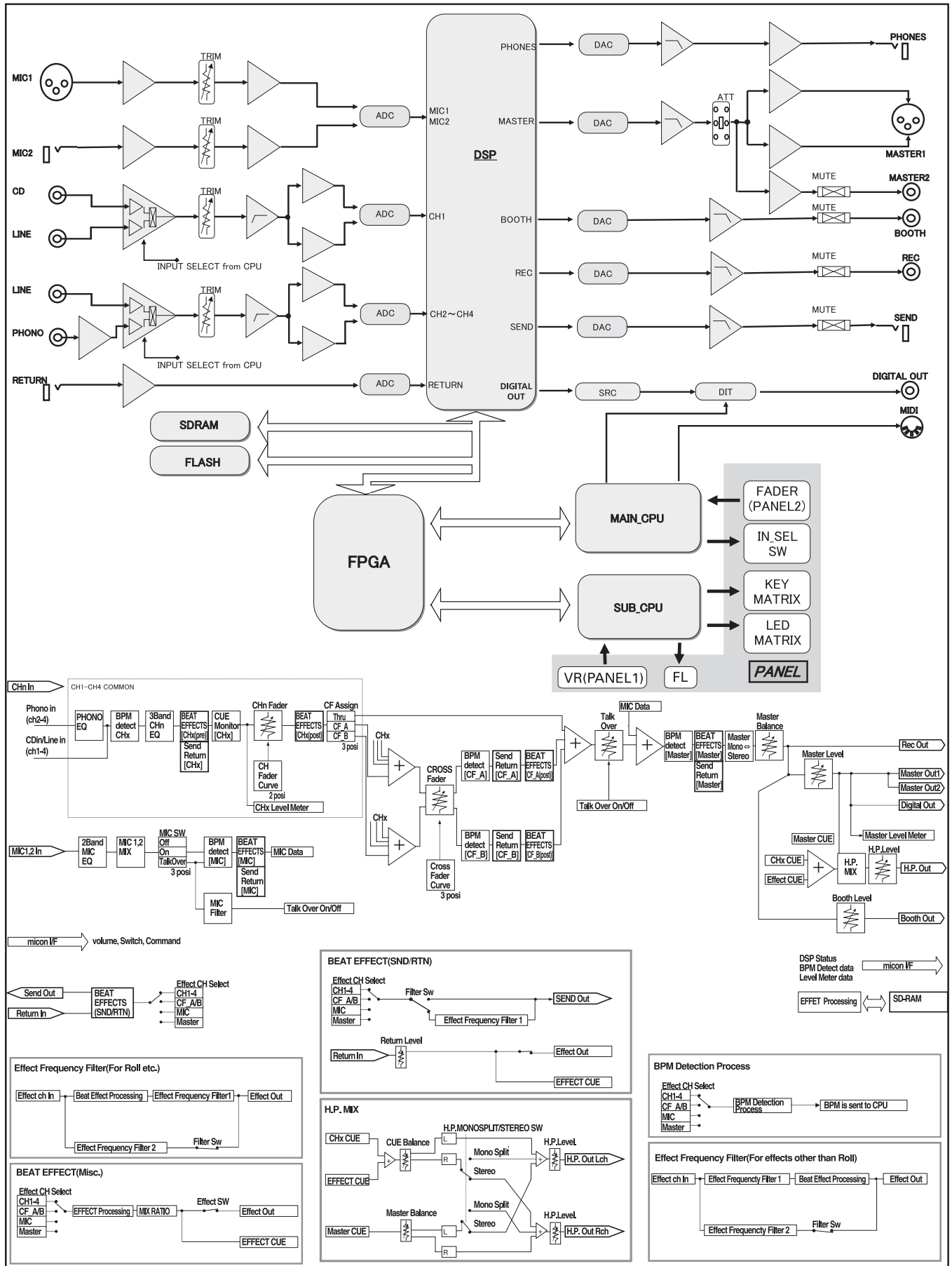

Published by Pioneer Corporation.
Copyright © 2007 Pioneer Corporation.
All rights reserved.

PIONEER CORPORATION

4-1, Meguro 1-Chome, Meguro-ku, Tokyo 153-8654, Japan

PIONEER ELECTRONICS (USA) INC.

Multimedia and Mass Storage Division: 2265 East 220th Street, Long Beach, CA 90810, U.S.A. TEL: 800-444-OPTI (6784)

PIONEER ELECTRONICS OF CANADA, INC.

Industrial Products Department: 300 Allstate Parkway, Markham, Ontario L3R OP2, Canada TEL: 905-479-4411

Printed in Malaysia

<DRB1426-B>